



Scaffolding & Formwork



**AHYAN SCAFFOLDING TRADING FZE. أحيان لتجارة السقالات م.م. ج.**

Scaffolding  
Formwork  
Safe Access  
Safety Equipment  
Special Made Fabrication  
Service -Refurbishment



trusted brand

سقالات  
صب الخرسانة  
الوصول المأمون  
معدات الأمان  
تجهيز الصنع الخاص  
تجديد الخدمة

# INDEX



<b>03</b>	.....About Ahyan
<b>04</b>	.....Major Supply Range
<b>05</b>	.....Cuplock Scaffolding System
<b>06</b>	.....Cuplock Scaffolding System
<b>07</b>	.....Slab Formwork
<b>08</b>	.....Slab Formwork
<b>09</b>	.....Wall Formwork
<b>10</b>	.....Light Weight Access Scaffolding, Aluminium Access Scaffolding, Heavy Duty Castor Wheel
<b>11</b>	.....Tubes & Fittings
<b>12</b>	.....Formwork Accessories
<b>13</b>	.....Fastners, Scaffolding Board & Timbers, Steel Beams
<b>14</b>	.....Structural Steel And Steel Fabricated Products, Service: Safety Mesh refurbishment
<b>15</b>	.....Scaffolding Tools And Consumables, Scaffolding Components

## ABOUT US

Over the past four years, Ahyan Scaffolding Trading FZE has accumulated a strong and healthy market trust through a simple principle that we follow:



### Earn Trust with Business

AHYAN Scaffolding Trading is a scaffolding company based in RAK FZE. We have been supplying Scaffolding and Formwork System and Components to the UAE market from our depot in Al Ghail in RAK since 2012. We supply new and used main Scaffolding and Formwork system / components of brands such as PERI, DOKA, HARSCO, RMD, ULMA and KHK. This allows for flexibility in a situation where you need to upgrade or top up your existing inventory to complete a system. Besides you will have the benefit of choosing the best from among the leaders in this industry in terms of quality, service, price and brand image.

We have never compromised on the quality and the services provided to the customer. So, we believe in keeping the customers happy and providing them with products at a very competent price. Please feel free to keep in touch with us about any of your business related requirements/queries. We look forward to a wonderful relationship together and success for all concerned.

### Our Objective

Our objective is to become one of the Scaffolding and Formwork System supplier with design and structural calculation as per our client requirement in one of the most competitive market in the world. Perfect quality is our perpetual pursuit. We will continue to offer more advanced technology, better products and services to all our customers.

### Our Goal

Customer satisfaction is the ultimate goal of our company.

### Mission Statement

We are committed to provide our products at the right time at the right place with zero tolerance.

### Vision Statement

To be referred as the most favorable company in the Scaffolding and Formwork trading industry.

### Our Achievements

The principles and standards of Ahyan Scaffolding has made the company one of the most reputed trading organization in UAE and we are able to satisfy all our clients who are based mainly in Sharjah, Dubai, Abu Dhabi, Fujairah, Ajman , Ras Al Khaimah , Qatar and KSA.





## MAJOR SUPPLY RANGE

- ✓ New and Used Cup lock Scaffolding System / Components.
- ✓ New and Used Kwikstage Scaffolding System / Components.
- ✓ New and Used Dokaflex Slab System / Components.  
(H20 Timber beam, New and Used Props and Fourway Head & Tripod)
- ✓ New and Used Peri Multiflex Slab System / Components .  
(H20 Timber beam, Props Fourway Head & Tripod)
- ✓ Used Dokamatic Table System / Components.
- ✓ New and Used Doka TOP 100/50 :- Timber beam  
Formwork System for single and double sided wall formwork  
shear wall, corewall , columns etc.
- ✓ New and Used PERI Vario:- Timber Formwork System / Components  
for single and double sided wall formwork , shear wall, corewall , columns etc.
- ✓ New / Used various size Circular column.
- ✓ New and Used Harsco ID 15 Stacking tower System.
- ✓ Used Doka D2 Stacking tower System.
- ✓ Used Mevadec Slab System.
- ✓ New / Used Aluminium Mobile towers and Accessories.
- ✓ Special made / Fabrication work as per customer demand.

## OUR SCOPE OF SUPPLY AT A GLANCE

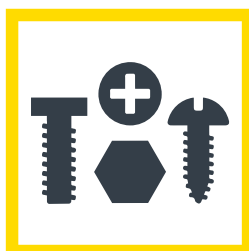
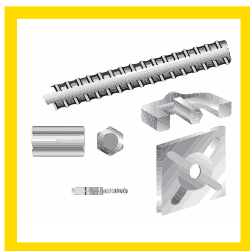
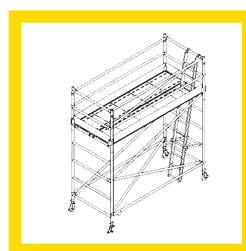
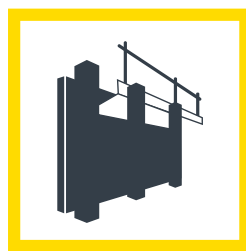
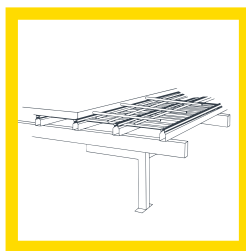
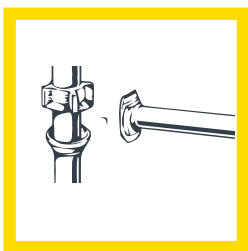

# CUPLOCK SCAFFOLDING SYSTEM In accordance with BS 1139



## BASE JACK

The Adjustable Base Jack is used the bottom of the Standard to provide an additional maximum adjustment of 500mm Permissible Axial Load 57kN.

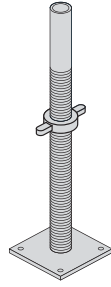

## LEDGER

All horizontals and transoms incorporate symmetrical forged blade ends making assembly quick and simple. Horizontals locate in the bottom cups of the standards are secured by locking the top cup.

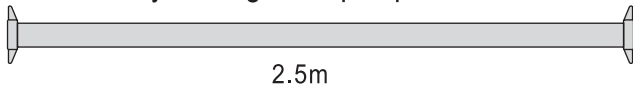

Available Sizes (m)						
2.5	1.8	1.6	1.3	1.2	0.9	0.6

## ADJUSTABLE & FIXED U HEAD

The Adjustable U-Head is used to support scaffolding beams such as H20, aluminum, steel waler and soldier. It has a hollow stem of 38mm nominal diameter which has a nut restraint to ensure the stem always has a minimum engagement into the Standard of 150mm. The fixed U head will serve the similar function and it only restrict the adjustment of height.

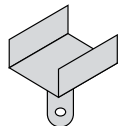
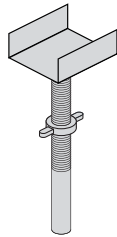

## UNIVERSAL JACK

The 57kN capacity universal screw jack has an adjustment range of over 500 mm. It is manufactured from 38mm outside diameter steel tube with a rolled square thread for fast trouble free operation.

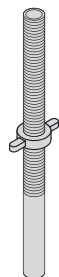

## BASE ADAPTER (Socket base)

It is a multifunctional accessory which provides a base for the universal jack, also connect universal jack to drop-head.

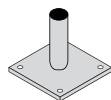

## STANDARD (Verticals)

Cuplock standards incorporate lower fixed cups at 0.5m intervals with captive rotating top cups which secure up to four components. Access standards incorporate a 150mm spigot at the top to allow the vertical connection of further standards.

Available Sizes (m)		
3.0	2.8	2.5
2.3	2.0	1.8
1.5	1.3	1.0

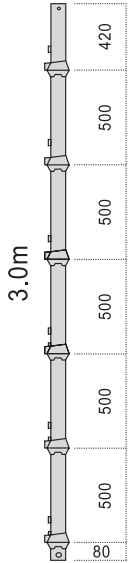

## SPIGOT

Standards are connected end to end by an internal Spigot. A Bolt is used to connect to the lower Standard.

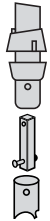

## INTERMEDIATE TRANSOM

It is used where scaffold boards require intermediate support between the span of two ledgers. generally intermediate transom placed every 1.30m span.

Available Size (m)

M	2.5	1.80	1.30
---	-----	------	------

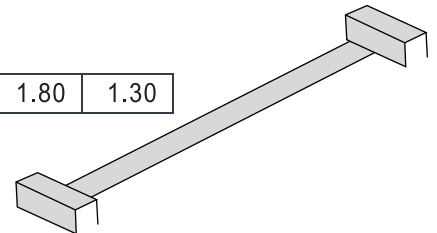

## HOP UP BRACKET

To expand the scaffold by cantilevering with minimum components for an additional 2, 1 or 3 board platform.

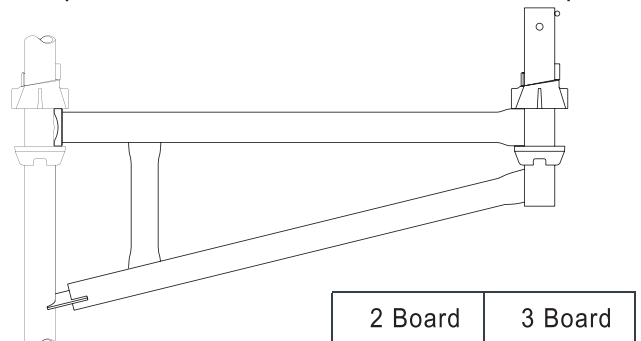



## DROP HEAD

Drop-head Supports the decking beams which are rested on the projected support. It is manufactured using high quality raw materials like extremely strong steel wedge. These drop heads are appreciated for their large load bearing capacity and being maintenance free.

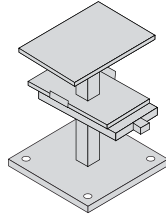

## DECKING BEAM

The light weight steel fabrication include a 100 mm wide top flange which eliminates the necessity for a plywood infill, so maintenance cost can cut down. Heavy duty pressing are fitted to the beam ends ensuring adequate protection against site abuse. These incorporate a tongue location for the drophead.

Available Sizes (m)		
2.50	1.80	1.20

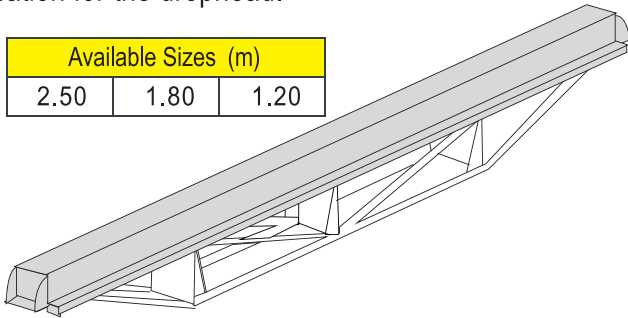

## STEEL PLANK (Batten)

Steel plank is widely used as temporary access platform with high load capacity and much durable than wooden planks. It is designed and manufactured with a non-slip surface for additional safety. Painted and galvanized finishes are available.

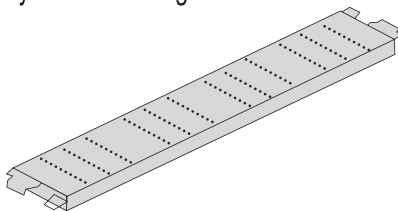

## SWIVEL FACE BRACE

Provides face bracing on a Cuplock access scaffold. Each brace has swivelling blade ends to allow for easy location within the node joint. As only one blade end can be located in each joint, parallel bracing is employed rather than the 'dog-leg' or 'zig-zag' method.

Available Sizes (m)					
X	3.0	2.5	2.5	1.8	1.8
Y	2.0	2.0	1.5	2.0	1.5

## INFILL BEAM

The infill beam have been designed to be used with the Decking beam to provide a support for plywood decking. The infill beam come in 4 length to allow for flexibility of grid sizes to suit all type of slabs. A timber beam shoe is also available for small timber make-up.

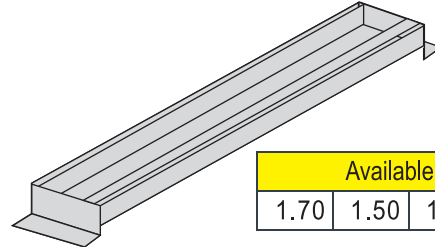

Available Sizes (m)				
1.70	1.50	1.20	0.90	0.50

## CANTILEVER 'A' FRAME

Cantilever frame system support the formwork beyond the external periphery of the slab. The cantilever is useful where the vertical support is restricted to use and it has blade ends for locating in the cup joint and accept adjustable jacks in three positions of 1.2m, 1.25m and 1.3m.

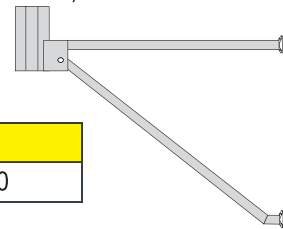

Available Sizes (m)	
1.5	1.0

## ADJUSTABLE STEEL PROP JACK (Telescopic)

It is a most commonly applied in all civil construction sites to support concrete elements. It can also serve for multipurpose. light / medium / heavy duty are available.

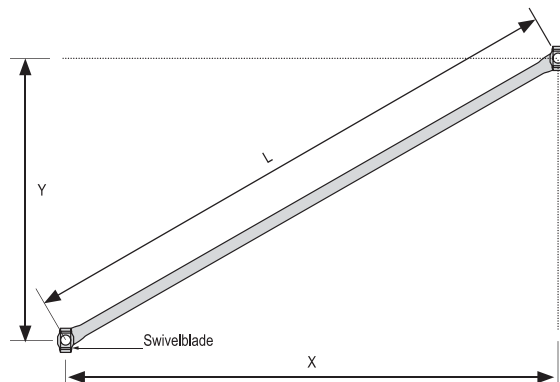
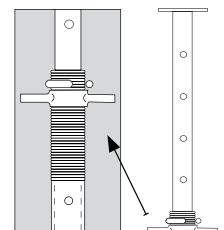

## SLAB FORMWORK

Versatile slab formwork for ceilings in residential and industrial buildings

- Small number of individual parts
- Optimised material deployment
- For any slab thickness
- Length adjustment through overlapping of girders
- Light-weight individual parts
- Optimised adjustment to any layout
- Any formwork covering selectable

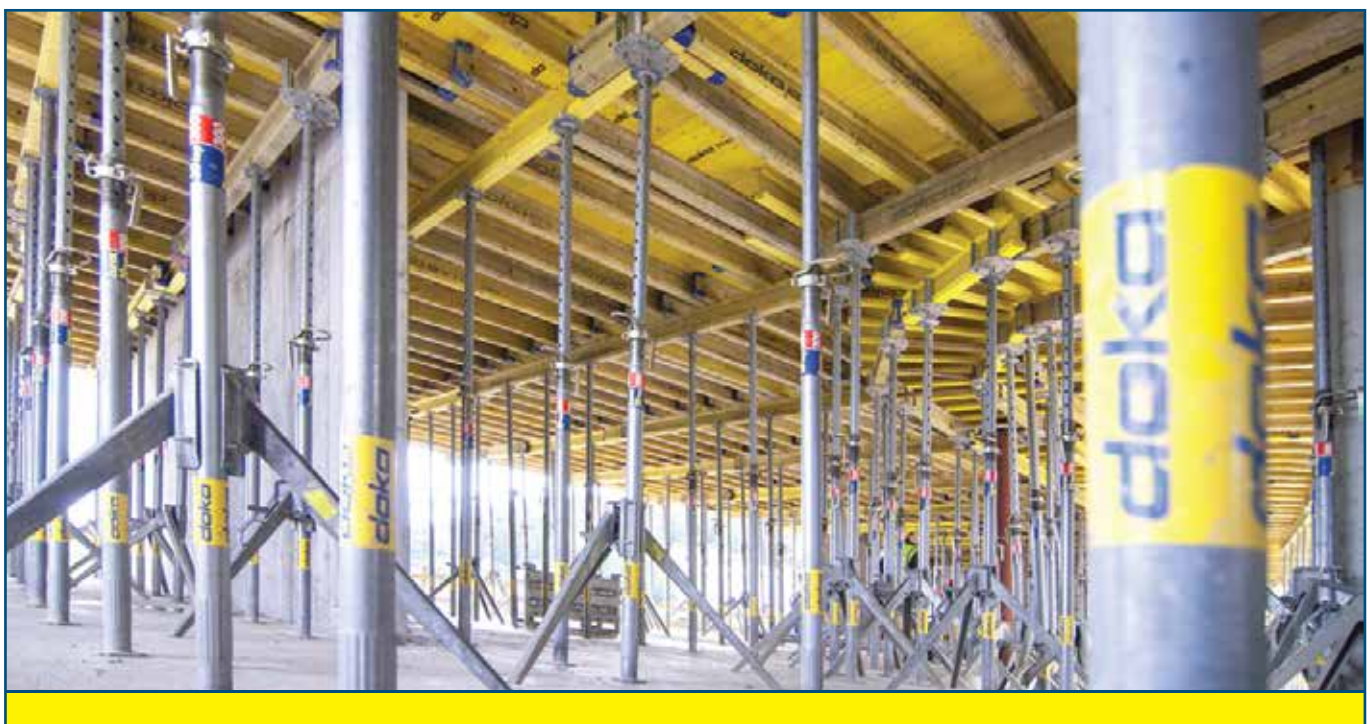
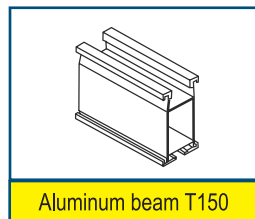
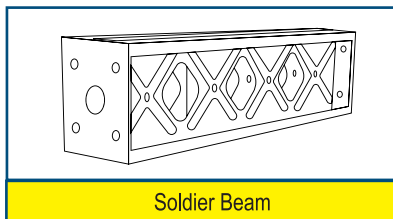
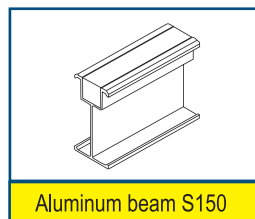
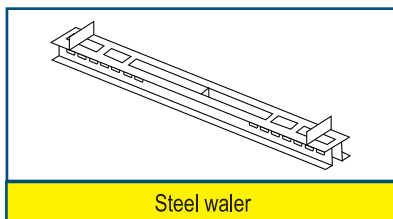
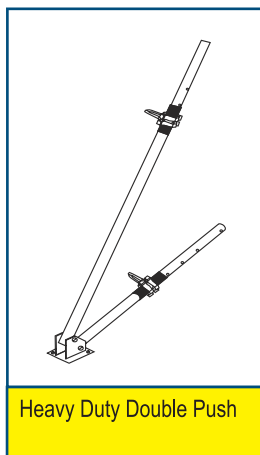
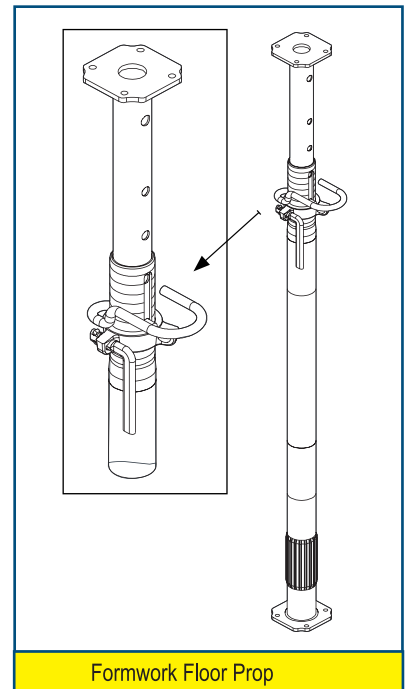
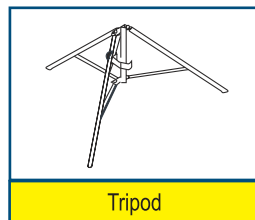
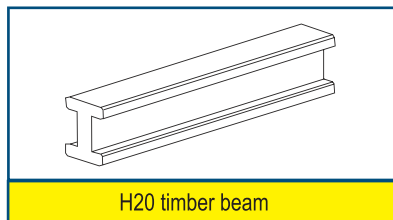
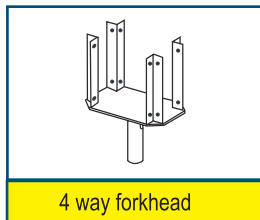





trusted brand



USED DOKA FLOOR PROP EUREX - VARIOUS SIZE 3.5 M, 4.0 M, 5.5 M



USED DOKA FLOOR PROP ECO 20 - 350, 20 - 400



DOKA NEW TIMBER BEAM , VARIOUS SIZE ECO - P



USED PERI USED PEP PROP 20 - 350, 20 - 400, 20 - 500



USED ULMA EP 20 - 3.0 M, 3.5 M PROP



NEW PFEIFER TIMBER BEAM VARIOUS SIZE - MADE IN EUROPE



USED HUNNEBACK EUROPLUS PROP 20 - 350, 20 - 400



USED RMD TABLE PROP. RANGE: 2390MM - 3430MM



PERI USED GT 24 GIRDER - VARIOUS SIZE



NEW KAUFMANN / SUPER H20 VARIOUS SIZE - MADE IN EUROPE



DOKA/PERI/KAUFMANN USED H20 BEAM



RMD GTX USED TIMBER BEAM VARIOUS SIZE



PERI NEW VARIOUS SIZE VT 20 TIMBER BEAM



USED ALUMA ALU. BEAMS VARIOUS TYPE AND SIZE



USED DOKA R. FOLDING TRIPOD



USED DOKA TABLE HEAD E20 & E30



USED PERI FORK HEAD - 24/20



USED ULMA TRIPOD - PAINTED



USED PERI UNIVERSAL TRIPOD



USED DOKA FOURWAY HEAD



USED ULMA TRIPOD - GALVANIZED



USED DOKA TABLE TROLLEY



## WALL FORMWORK

Versatile , durable Wall formwork forceillings in residentialand industrial buildings

- Small number of individual parts
- Optimised material deployment
- For any Wall thickness
- Light-weight individual parts
- Easy erection and dismantling.
- Length adjustment throughoverlapping of girders and steel walings



USED PERI VARIOUS SIZE SRZ WALER AND SUPPORTING ACCESSORIES (VARIO SYSTEM)



NEW / USED GHI STEEL WALER - VARIOUS SIZE

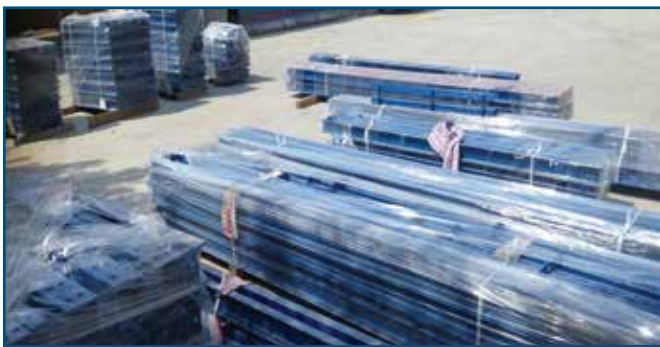

NEW OR USED DOKA VARIOUS SIZE STEEL WALER



NEW / USED RSS PUSH PULL PROP



USED DOKA VARIOUS SIZE MULTI PURPOSE WALER AND SUPPORTING ACCESSORIES



NEW / USED RMD & SGB SOLIDERS



USED PERI CB 240 CLIMBING BRACKETS



USED PERI SINGLE SIDE BRACKET



NEW / USED DOKA FLANGE CLAMP H20



## LIGHT WEIGHT ACCESS SCAFFOLDING

The light weight frame scaffolding designed for easy access especially facades applications, painting, plastering masonry works etc. The system consist of H frame (W 1.0mx H 2.0m) and cross brace (2.50m / 3.0m), horizontal brace (2.50m / 3.0m). The frame is designed with built-in spigots which give easy and safe joining between the frames.



## ALUMINIUM ACCESS SCAFFOLDING



## HEAVY DUTY CASTOR WHEEL - 8 Inch



PU Wheel Base ( Revvo )



PU Wheel Base ( Flywheel )



Rubber Wheel Base  
( Male Type )



PU Wheel Base  
( Socket / Female )



## TUBES - EN 74 & FITTINGS - EN 39

We supply complete range of tubes and fittings. We can make a system adaptable for almost any access application  
Both pressed and drop forged fittings are available.

Tubes	
1	MS Pipe (Scaffolding), ERW
2	Galvanized Pipes
3	Galvanized Tubes (RHS, SHS, CHS)
4	Aluminum Pipes

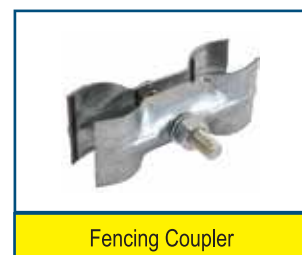
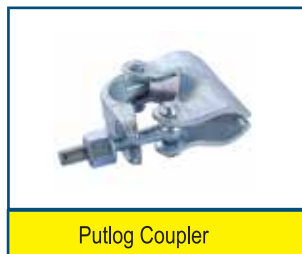
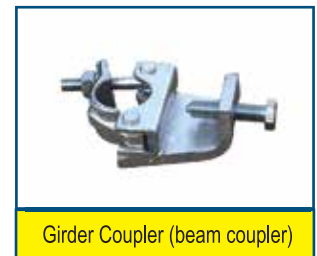
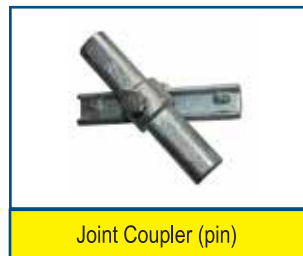
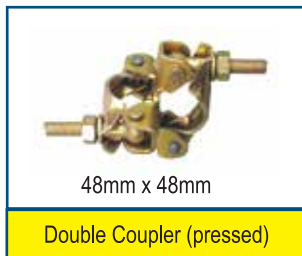
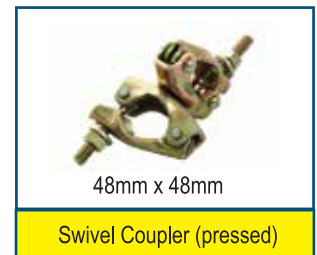
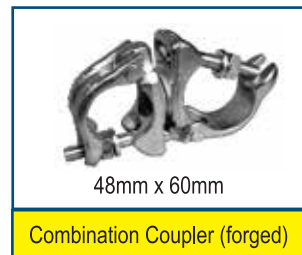
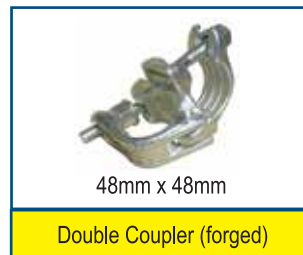
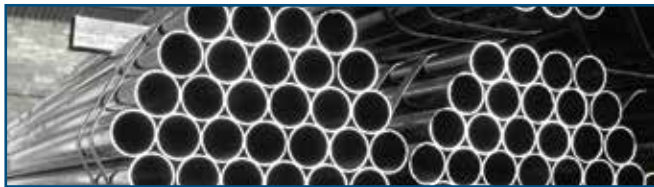





## FORMWORK ACCESSORIES (lost and re-usable items)

Formwork accessories are required in the production of in-situ concrete components in order to maintain the wall thickness and to anchor the formwork. We offer a comprehensive range of products. This includes lost and re-usable items and various plastic profiles.

### TIE BAR SYSTEM - GERMAN ORIGIN ( SAS )



Formwork Accessories					
1	Tie Rod 16mm & 20mm dia	5	Hex Nut Coupler	9	Loop Anchor
2	Water Stopper (Water Bar) 16mm & 20mm dia	6	H20 Flange Clamp	10	PVC Cone For Tie Rod
3	Shuttering Clamp 4 ,'3 ,2.5'	7	Washer Plat / Counter Plate 120x120mm	11	Wing Nut 16mm & 20mm dia tie rod
4	Rapid Clamp	8	Universal Clamp	12	Steel Cone for Anchoring System





## FASTNERS

1	Carriage Bolt	4	MMS Anchor Bolt (Hesco)	7	Shield Anchor Bolt
2	Hex Bolt / Screw Bolt	5	T Bolt	8	Lifting Eye Bolt
3	Drop Anchor	6	Anchor Bolt (through bolts)	9	Lag screw

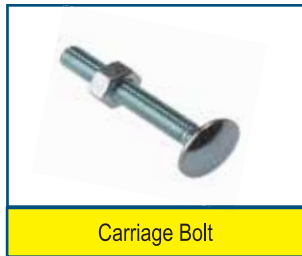

## SCAFFOLDING BOARD & TIMBERS

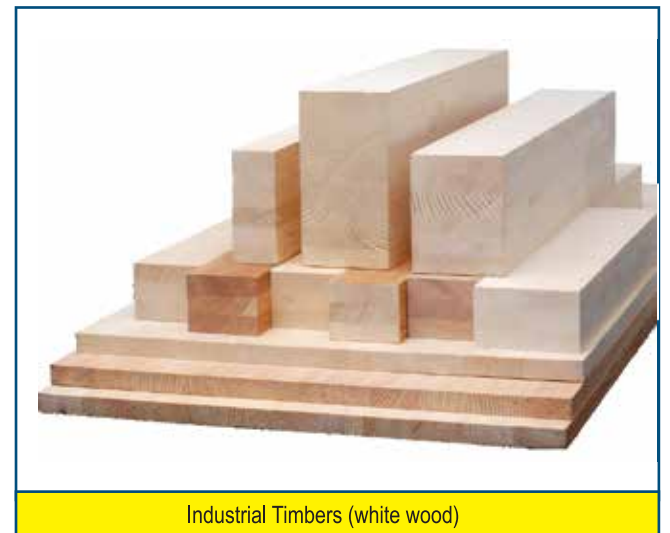
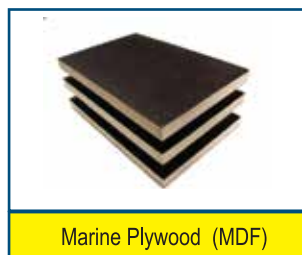

## STEEL BEAMS

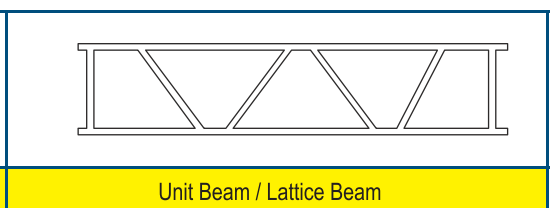
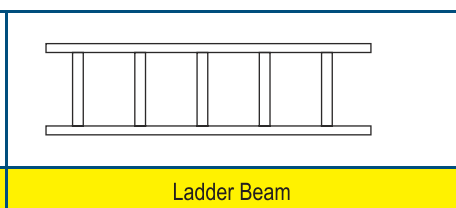
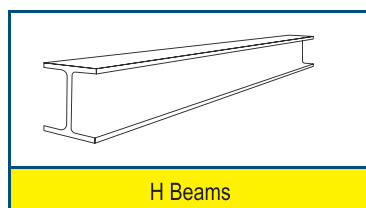





## STRUCTURAL STEEL AND STEEL FABRICATED PRODUCTS

1	Steel Angles ( equal and unequal )	5	Solid Bar	9	G.I. Chequered Plate
2	UPN Channel	6	Steel Plate ( HR Sheet )	10	Steel pallet
3	Flat Bar	7	Galvanized Grating	11	Accessory Bin ( Steel )

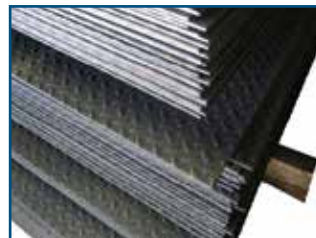
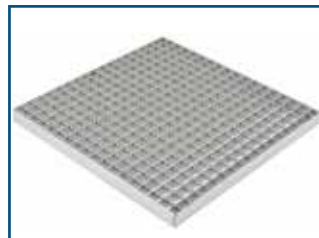
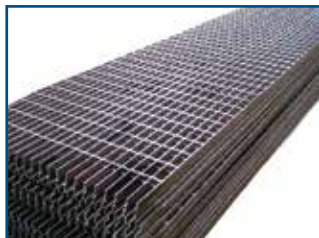

## SERVICE : Safety Mesh refurbishment





## SCAFFOLDING TOOLS AND CONSUMABLES



Scaffolding Spanner



Scaffolding Ratchet Spanner 21/17



Magnetic Spirit Level



Measuring Tape



Digital Vernier



Scaff Accessory Lifting Bag



Scaffolding Tag (safety tag)



Scaffolding Tool Belt



Scaffolding Green Net



Scaffolding Hammer



Analogue Vernier



Workers Water Cooler

## SCAFFOLDING COMPONENTS

1	Cuplock Top Cup (forged)	3	Cuplock Bottom Cup (forged)	5	Ledger end Blade
2	Jack Nut (forged)	4	Prop Sleeve & Nut	6	Toggle pin



G Pin ( propjack locking pin )



Cotter Pin



Cuplock Top Cup (forged)



Cuplock Bottom Cup



Ledger End Blade



Jack Nut



Prop Sleeve & Nut



Toggle Pin



# AHYAN

Scaffolding & Formwork

Various type Slab Formwork  
Double sided Wall Formwork  
Lift Core Wall Formwork  
Various size & Type Column Formwork



Special made Arch / Circular  
Ceremonial Column  
Single side Wall Form Work  
Double / Single / Corewall  
Shearwall Formwork  
Round/ Circular column  
Cuplock / kwick stage Scaffold

ص.ب: 327548 - رأس الخيمة - الإمارات العربية المتحدة  
البريد الإلكتروني: ahyan@rakzbc.ae  
هاتف متحرك : 0551100248 , 0507883590  
هاتف : +9716-72041111 , +9716-7667088  
فاكس : +9716-7661088



www.ahyanast.com  
email:info@ahyanast.com

Post Box: 327548 - RAK - U.A.E  
Email: ahyan@rakzbc.ae  
ahyanscaffolding@gmail.com  
Cell: 0551100248, 0507883590  
Tel: + 9716- 7667088  
Tel: + 9717- 2041111  
Fax:+ 9716-7667088